

# BYME-A

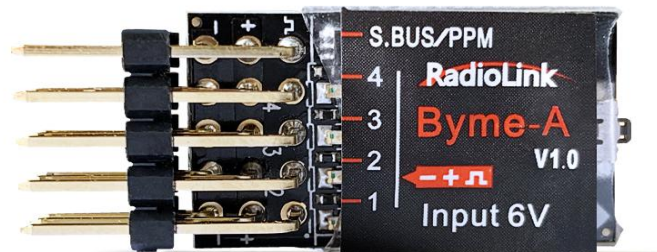

## Flight Controller of Fixed-Wing **Instruction Manual**

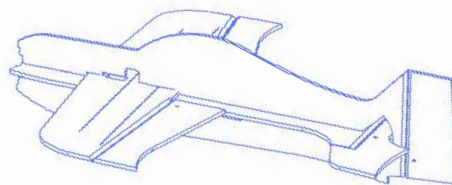

Thanks for purchasing Radiolink flight controller Byme-A .

To fully enjoy the benefits of this product and ensure safety, please read the introduction carefully and set up the device as described below:

If any problems found during the operation process, please kindly refer to the manual first.

Then pilots could contact our distributors to find solution or follow our Facebook homepage <https://www.facebook.com/Radiolink-1455452961436694/> to search related key words. Also

pilots can send questions to [after\\_service@radiolink.com.cn](mailto:after_service@radiolink.com.cn) or

[after\\_service1@radiolink.com.cn](mailto:after_service1@radiolink.com.cn) and we will answer your question at the earliest.

Due to unforeseen changes in production procedures, the information contained in this manual is subject to change without notice.

For more information please check our website <http://www.radiolink.com> and follow our Facebook and youtube homepage.



### **SAFETY PRECAUTIONS**

- Never operate model during adverse weather conditions. Poor visibility can cause disorientation and loss of control of pilots' model.
- Never use this product in a crowd and illegal area.
- Always ensure the trim levers at 0 and battery properly charged before connecting the receiver.
- Always check all servos and their connections prior to each run.
- Always be sure about turning off the receiver before the transmitter.
- To ensure the best radio communication, please enjoy the flight/driving at the space without interference such as high voltage cable, communication base station or launching tower.

### **WARNING**

This product is not a toy and is **NOT** suitable for children under the age of 18. Adults should keep the product out of the reach of children and exercise caution when operating this product in the presence of children.

Water or moisture may enter the transmitter inside through gaps in the antenna or joystick and cause model instability, even out of control. If running in the wet weather (such as game) is inevitable, always use plastic bags or waterproof cloth to cover the transmitter.

## 1. Introduction

Byme-A is a flight controller applicable to various straight wing aircraft including 3D fixed wing(F3P) and 4-channel trainer and scale model aircraft and is SBUS and PPM signal supported. With the three-axis gyroscope and three-axis acceleration sensor and the full attitude algorithm, control algorithm and digital filter, Byme-A makes the flight much easier. There are five flight modes: Vertical Mode, Stabilize Mode, Gyro Mode, Acro Mode, Manual Mode.

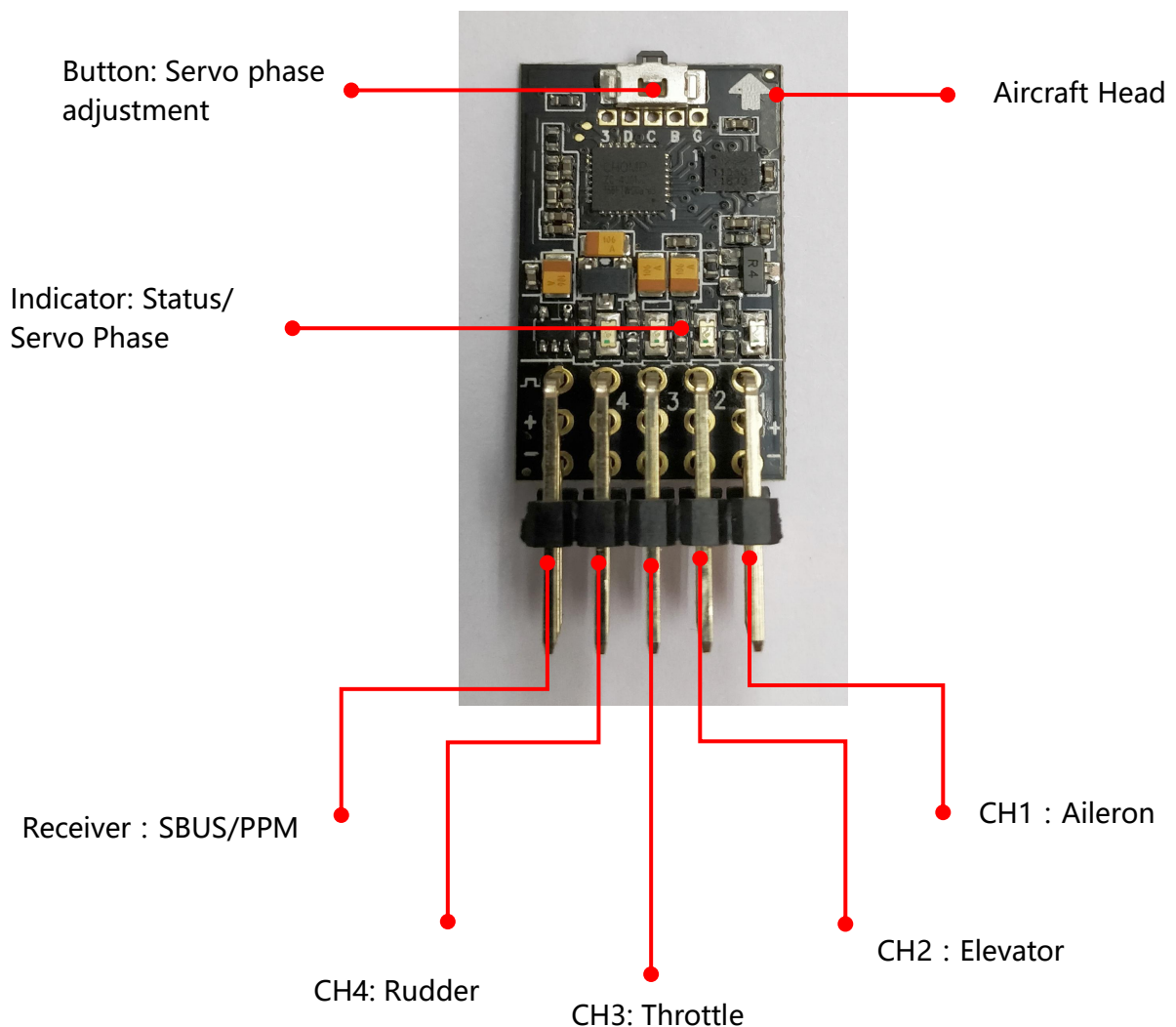

## 2. Parameters

Input Voltage : 6-12V

Pin : 2.54mm \* 3 pin \* 5

Weight: 4.5g (with wires)

Dimension: 35.5\*15.5\*10.5mm

## 3. Installation

Make sure the arrow on Byme-A points to the aircraft head. The flight controller can be installed either face up or down with 3M glue on the aircraft body (better around the center) and the wires connect to the corresponding pins.

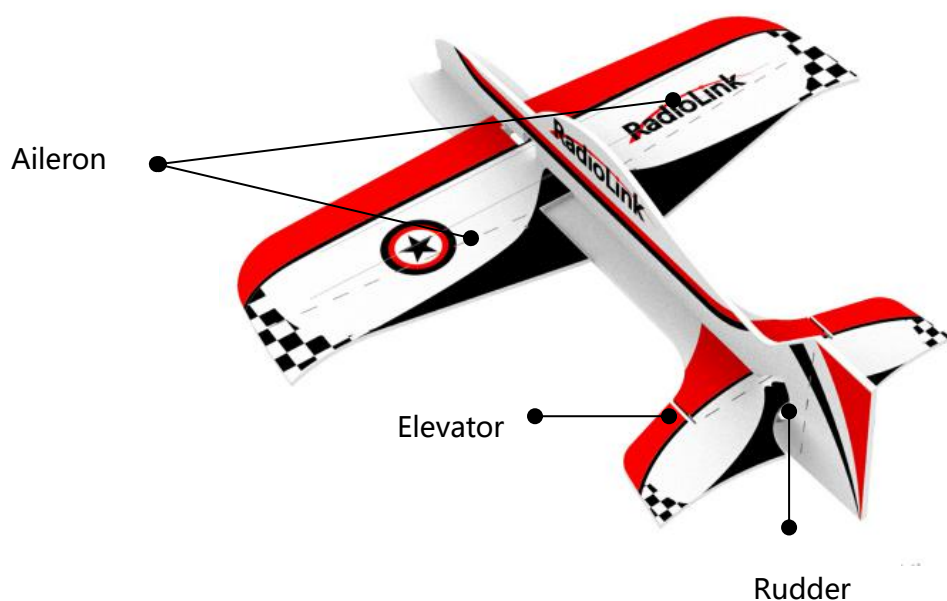

## 4. Flight Modes Setup

Flight modes can be set by CH5 (3-way switch) and CH7 (2-way switch) on transmitter with five modes: Vertical, Stabilize, Gyro, Acro and Manual.

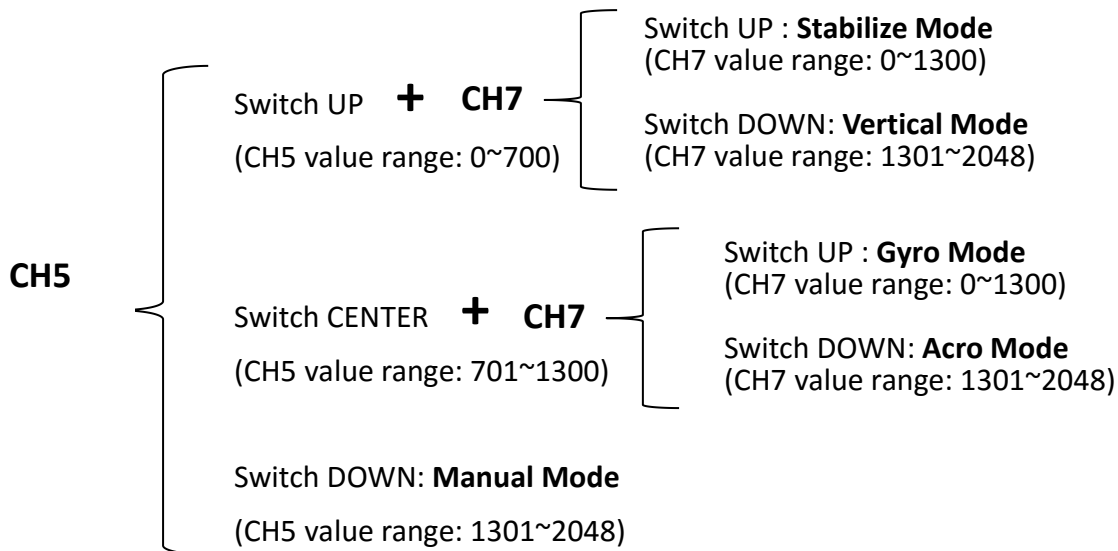

## 5. Transmitter Phase Setup

CH3 - Throttle: Reversed

Other channels: Normal

## 6. Power-On Calibration

When the aircraft is powered on, the gyro on Byme-A will calibrate with the green led flashing. Please keep the aircraft remain still until the green light is always on.

## 7. Attitude Calibration

Byme-A needs to calibrate the attitudes/level to ensure the balanced status.

It is advised to lift up the model head with a certain angle to ensure the calibration accuracy and it will be recorded once the attitude calibration is complete with success.



Pull both joysticks to outside corners as below and hold more than 3 seconds. The green led flashes once means the calibration completed.



## 8. Servo Phase

Make sure the servo phases are correct before flight.

Take Manual Mode and Mode 2 as example.

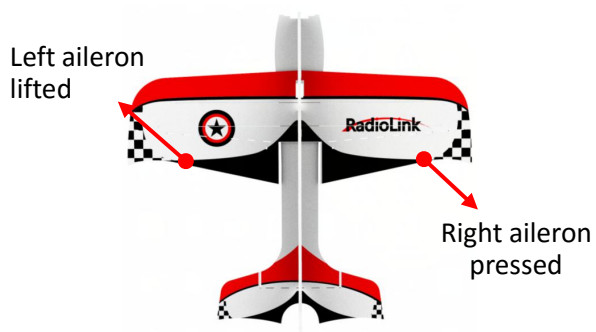

Pitching to left



Pitching downward



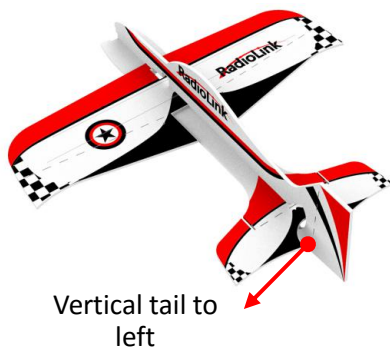

Rudder to left



Reversed servo phases can be adjusted by the flight controller Byme-A.

### 9. Output Servo Phase Adjustment

Press the button at the front of Byme-A to change the servo phase:

Short press once, aileron servo reversed, LED1 ON/OFF.

Short press twice, elevator servo reversed, LED2 ON/OFF.

Short press four times, rudder servo reversed, LED4 ON/OFF.

Note: Make sure attitude calibration is complete before changing the servo phases. Byme-A will identify the installation position (above/bottom of the aircraft ) to automatically adjust the gyro direction.

### 10. Flight Modes

#### ① Stabilize Mode

The model attitude (inclination angles) is controlled by joysticks.

The max inclination angle is 70° for rolling while that for pitching is 45°.

Model leans to left  
(move to left)



Rolling to left





Model leans to right  
(move to right)

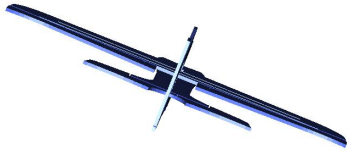

Rolling to right



Model head lifts  
(move backward)

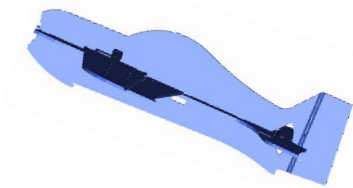

Pitching downward



Model head pressed  
(move forward)

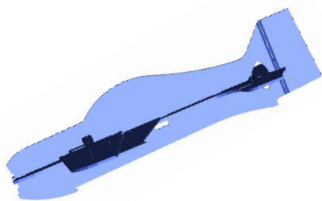

Pitching upward



Model directions  
changed

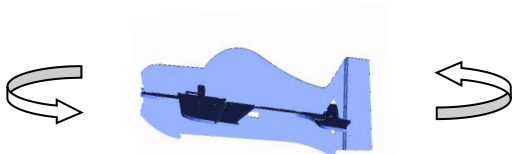

Rudder left/right





## ② Vertical Mode

Under this mode, the aircraft will remain vertical posture and direction.

The altitude algorithm of Byme-A maps the joystick operation onto horizontal ordinates and takes control of full altitude.

By toggling the rolling joystick (CH1), the aircraft will move left and right.



By toggling the pitching joystick (CH2), the aircraft will move forward and backward.



By toggling the rudder joystick (CH4), the aircraft will rotate.

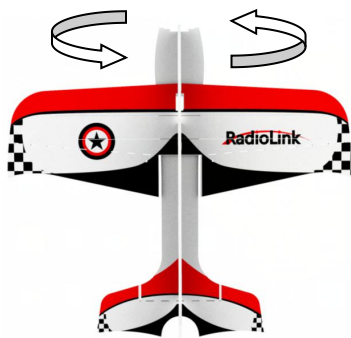

## ③ Gyro Mode

The model rotation (angular velocity) is controlled by joysticks with three-axis gyro increasing the stability. The aircraft will rotate with corresponding velocity

by toggling the joysticks of rolling, pitching and rudder. This is the advanced mode and the model won't level but and keeps rotating when joystick is loose .

#### ④ Acro Mode

This mode is the combination of Stabilize Mode and Gyro Mode.

When the joystick is at center point, aircraft will level.

When toggle joysticks with small range, aircraft will move to the corresponding directions.

When toggle joysticks with large range, aircraft will rotate to the corresponding directions.

For example,

Models moves anticlockwise

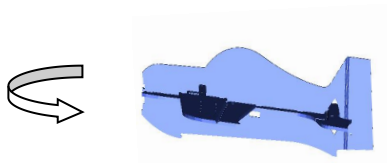

Rudder to left  
(with small range)



Models rotates anticlockwise

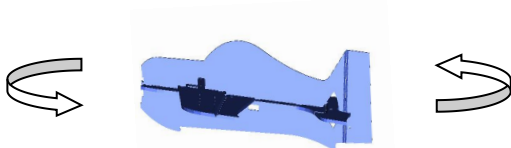

Rudder to left  
(with large range)



#### ⑤ Manual Mode

Pilots control servos with corresponding channels by transmitter, neither attitude nor gyro involved.

## 11. Gyro Sensitivity

There is certain stability margin for the Byme-D PID control. To different models, if Byme-D under correct or over correct, pilots can try adjusting the rudder angle.

**Thank you again for choosing Radiolink product**